

SKILL LEVEL



BEGINNER

multisized
pattern...sizes
6/8/10/12/14/16
/18/20/22/24/26
all together!

*www.hotpatterns.com*tm
patterns so hot they're smokin'...

HotPatterns & fabric.com exclusive download
Easy Breezy Knit Vest



This sweetly pretty Vest is a versatile addition to your weekend or casual wardrobe, and just perfect for fluid knits with a little stretch...try silk, bamboo, cotton modal, tencel, viscose or rayon jersey, or even a lightweight sweater knit. Relaxed-fit, tie-front Vest has narrow knit rib or self fabric trim at neckline and armholes; front closes with a gorgeous tie. Vest features 'V' front neckline & a contrast 'V' shaped insert at the back, and finishes with a drapey narrow-stitched hemline, which is longer at the sides. Wear this great layering piece over a simple T-shirt, top or blouse for instant weekend chic, or try it as a casual evening cover-up with a sparkly sequined tank, your favorite jeans and some killer heels.

Hot Patterns & fabric.com

exclusive free download easy breezy knit vest instructions page 1 of 2

SEAM ALLOWANCES & OTHER INFO

Seam allowances are 3/8" wide; all seams are sewn right sides together unless otherwise stated.

Skills needed include: sewing with knits (it's easy!); applying a neckband & knit armholes; working a narrow hem.

Depending on the recovery of your fabric or rib, you may have to shorten the neck and/or armhole bands... see our note in the circle below...

ABOUT THIS STYLE

This Vest has a relaxed-fit with a tie-front; the hem is cut away at the center front & back, and longer at the sides.

The body of the vest is finished with a narrow hem; the armholes & neckline are finished with contrast or self-fabric trim.

We usually recommend making a muslin before you cut your fabric; again, see our special note in the circle below ...you'll probably be better off just 'going for it' and adjusting as you go for this one!

FABRIC REQUIRED

All sizes need around 1 & 1/4 yards/xxcm of 60"/150cm wide fabric for the vest. You'll also need enough about 1/4 yard/22.5cm of contrast fabric for the insert, the armholes, and the neck trim & tie.

SUGGESTED FABRIC CUTTING LAYOUT FOR VEST

fold fabric in half from selvedge to selvedge for this layout

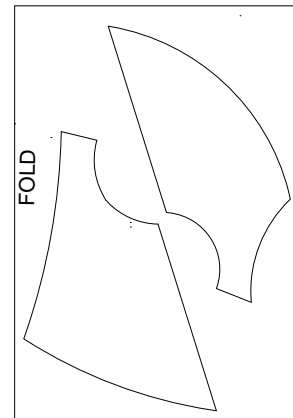

PLEASE NOTE

All knits are not created equal!
This means that you may get to steps 4 & 5, and find that your neckline and/or armhole trim is too long (or rather, has too much stretch) in which case, just shorten it to your taste...sorry, no magic formulas here, it's entirely up to you!

SUGGESTED FABRIC CUTTING LAYOUT FOR THE CONTRAST INSERT, ARMHOLE & NECKLINE TRIM

unfold fabric so it lays flat for this layout

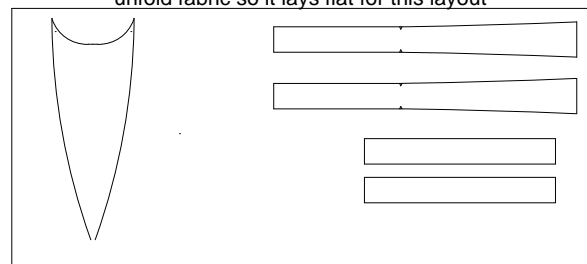

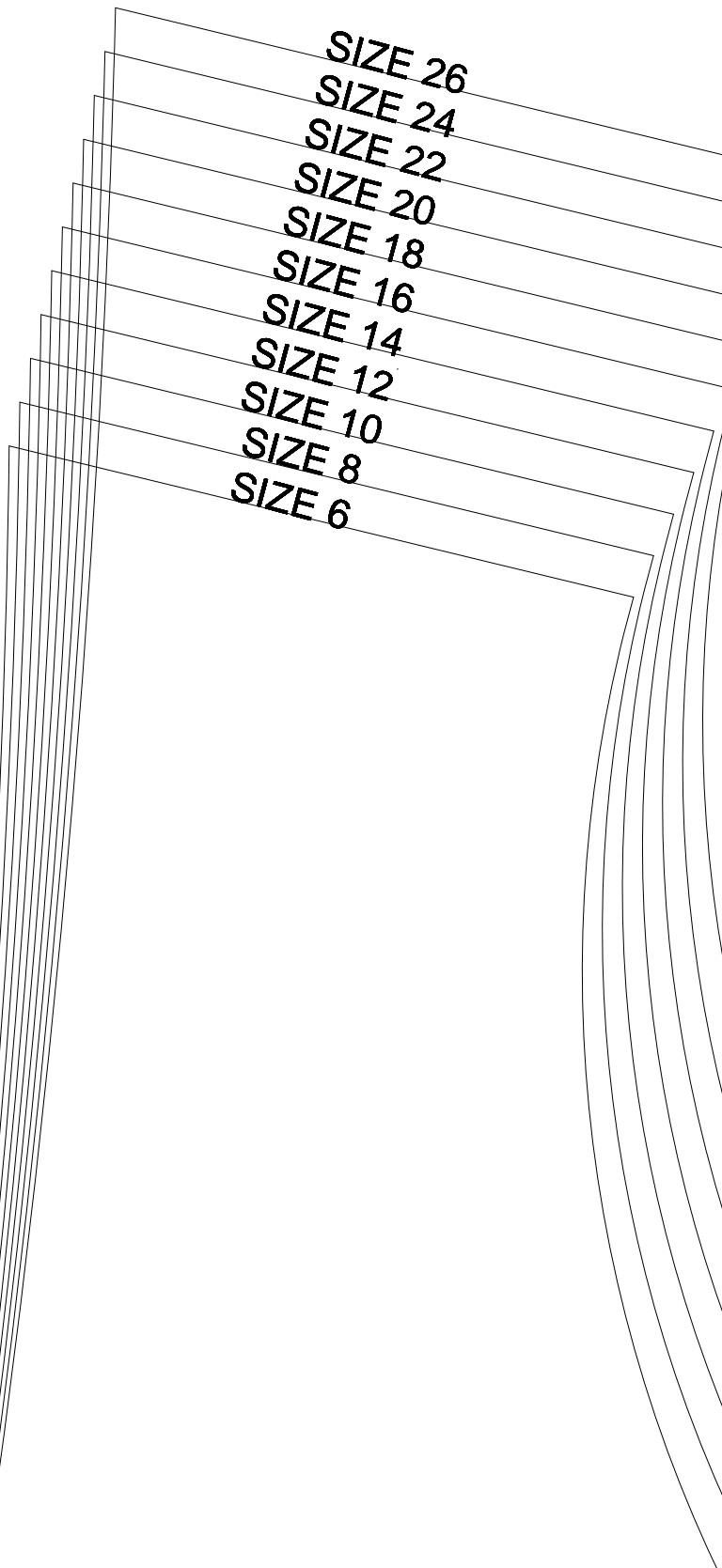

SIZE 26
SIZE 24
SIZE 22
SIZE 20
SIZE 18
SIZE 16
SIZE 14
SIZE 12
SIZE 10
SIZE 8
SIZE 6

5



Hot Pattern

exclusive f

easy bre

b

cut 1 pa

8

STRETCH

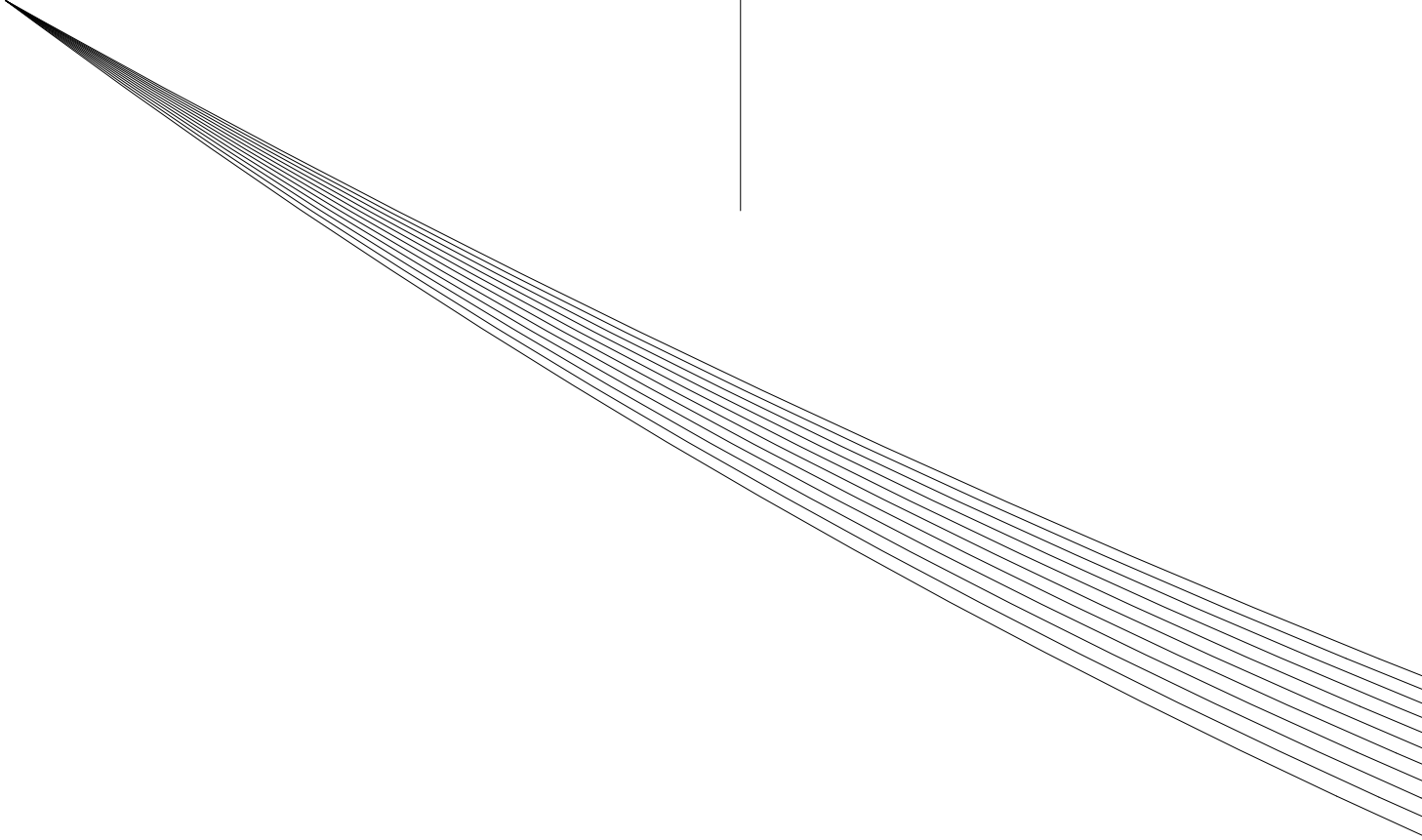

SIZE 26

SIZE 24

SIZE 22

SIZE 20

SIZE 18

SIZE 16

SIZE 26

SIZE 24

SIZE 22

11

SIZE 14

SIZE 12

SIZE 10

SIZE 8

SIZE 6

SIZE 20

SIZE 18

SIZE 16

SIZE 14

SIZE 12

SIZE 10

SIZE 8

SIZE 6

STRET

Hot Patterns & fabric.c

exclusive free download
easy breezy knit vest
neckline trim & tie
cut 1 pair in contrast

Hot Patterns & fabric.com

CUT DIRECTION

exclusive free download
easy breezy knit vest
armhole trim
cut 1 pair in contrast

com

STR

14

17

ETCH DIRECTION

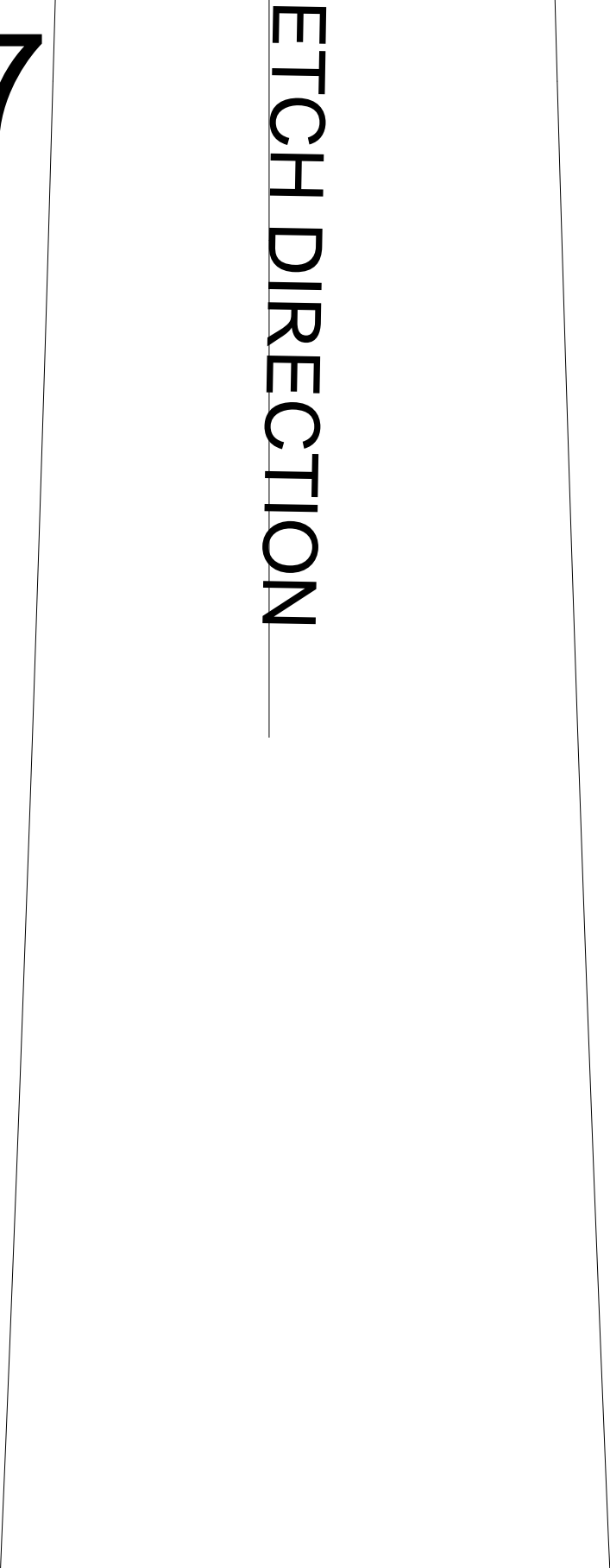

SIZE 26
SIZE 24
SIZE 22

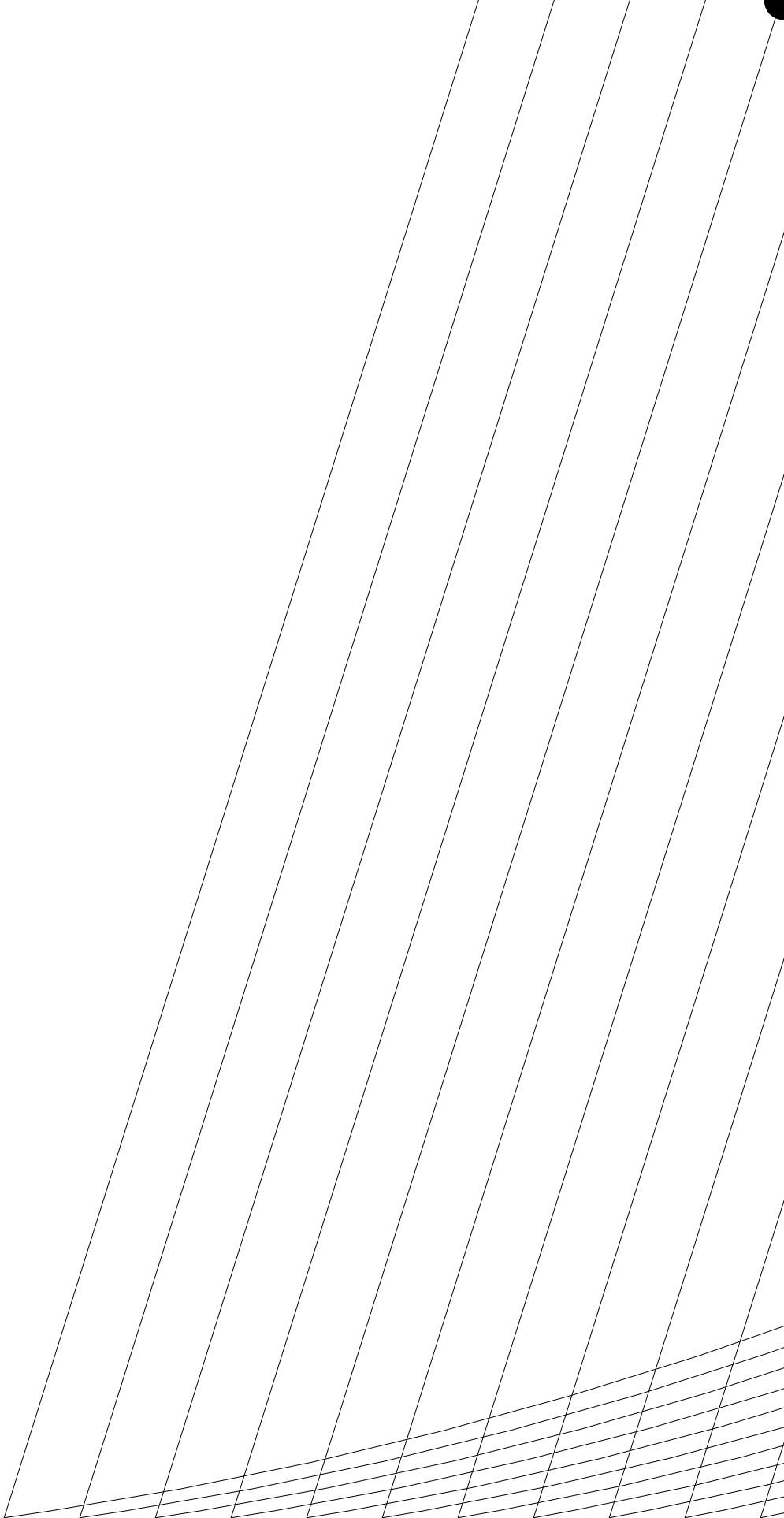

instructions page 2 of 2

- 1** Join the 2 short ends of the armhole trim to make a pair of loops;
Press the seam allowances open; fold the loops in half lengthways.

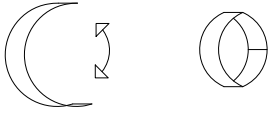

- 2a** Join the neck trim/ties pieces at the center back seam, and press the seam open.

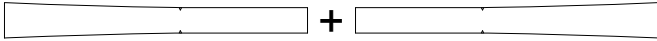

2b

Finish the tie ends by folding in half lengthways (right sides together) and join the edges from the short edge to the center front notch.

Clip the corners, press the seams open and turn the tie out to the right side. Press flat, and set aside until step 6.

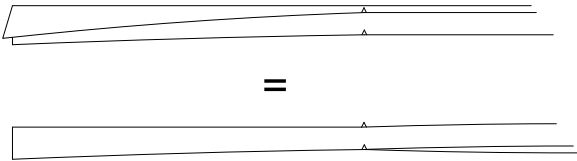

- 3** Join the fronts to the backs at the side seams.
Press the seam allowances open, then work a narrow hem all along the bottom edges...

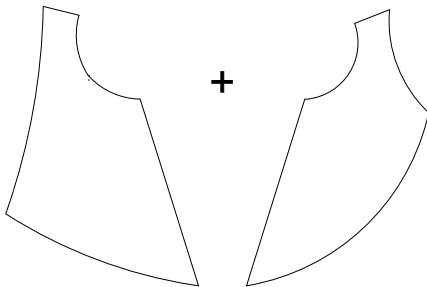

...for a narrow hemmed edge: sew a line of straight stitches along the edge of the fabric, about 1/4" or 0.65cm in from the cut edge. Press the edges under along this line of stitching, then press this folded edge under 3/8" or 1cm. Hem along this double-folded edge. Press flat.

- 4** Join the contrast back insert to the backs along the curved seams.
Press the seam allowances open, then press the seam allowances towards the armholes.

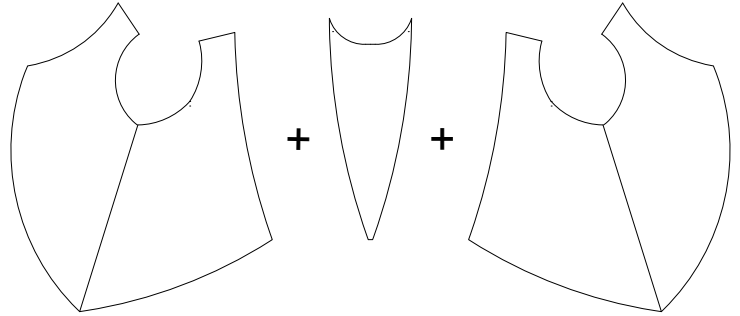

- 5** Join the fronts to the backs along the shoulder seams.
Press the seam allowances open.

- 6** Matching the seam on the armhole trim to the side seams, and easing where necessary, join the armhole trim to the vest armhole.

Matching the center back seam on the neck trim/tie to the center back of the vest, join the neck trim/tie to the vest neckline... match the notches on the tie to the center front of the vest.

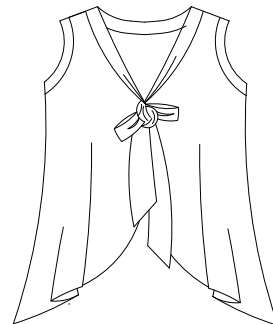
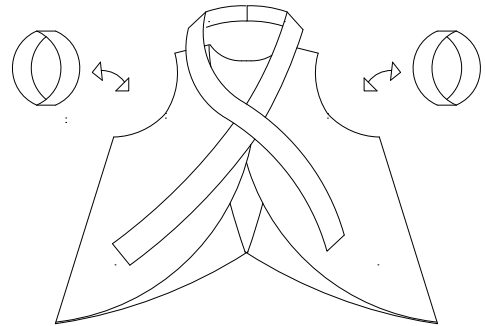

Press flat and you are done...fabulous!

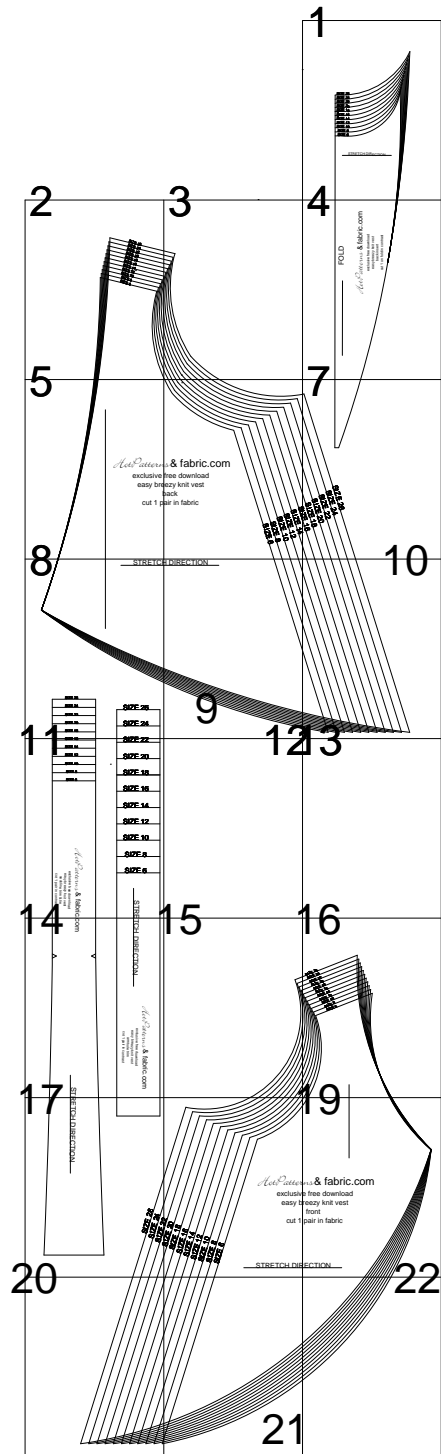



s & fabric.com

free download
easy knit vest
back
air in fabric

SIZE 14
SIZE 12
SIZE 10
SIZE 8
SIZE 6

9

SIZE 20
SIZE 18
SIZE 16
SIZE 14
SIZE 12
SIZE 10
SIZE 8
SIZE 6

Hot Pattern

exclusive
easy br

cut 1

STRETCH DIR

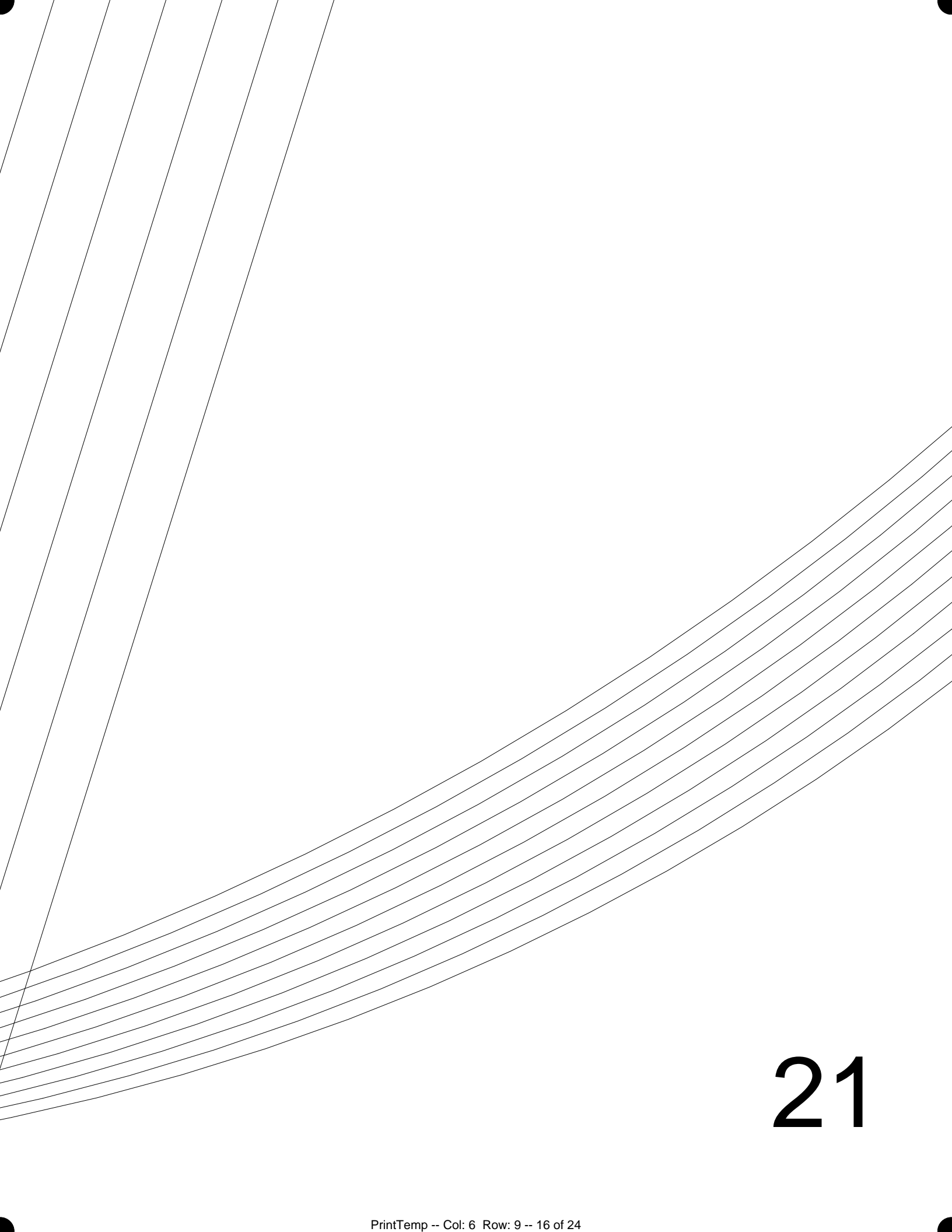

- SIZE 26
- SIZE 24
- SIZE 22
- SIZE 20
- SIZE 18
- SIZE 16
- SIZE 14
- SIZE 12
- SIZE 10
- SIZE 8
- SIZE 6

STRETCH DIRECTION

FOLD

Hot Patterns & fabric.com

exclusive free download
easy breezy knit vest
back insert
cut 1 on fold in contrast

7

SIZE 26

SIZE 24

SIZE 22

SIZE 20

SIZE 18

SIZE 16

10

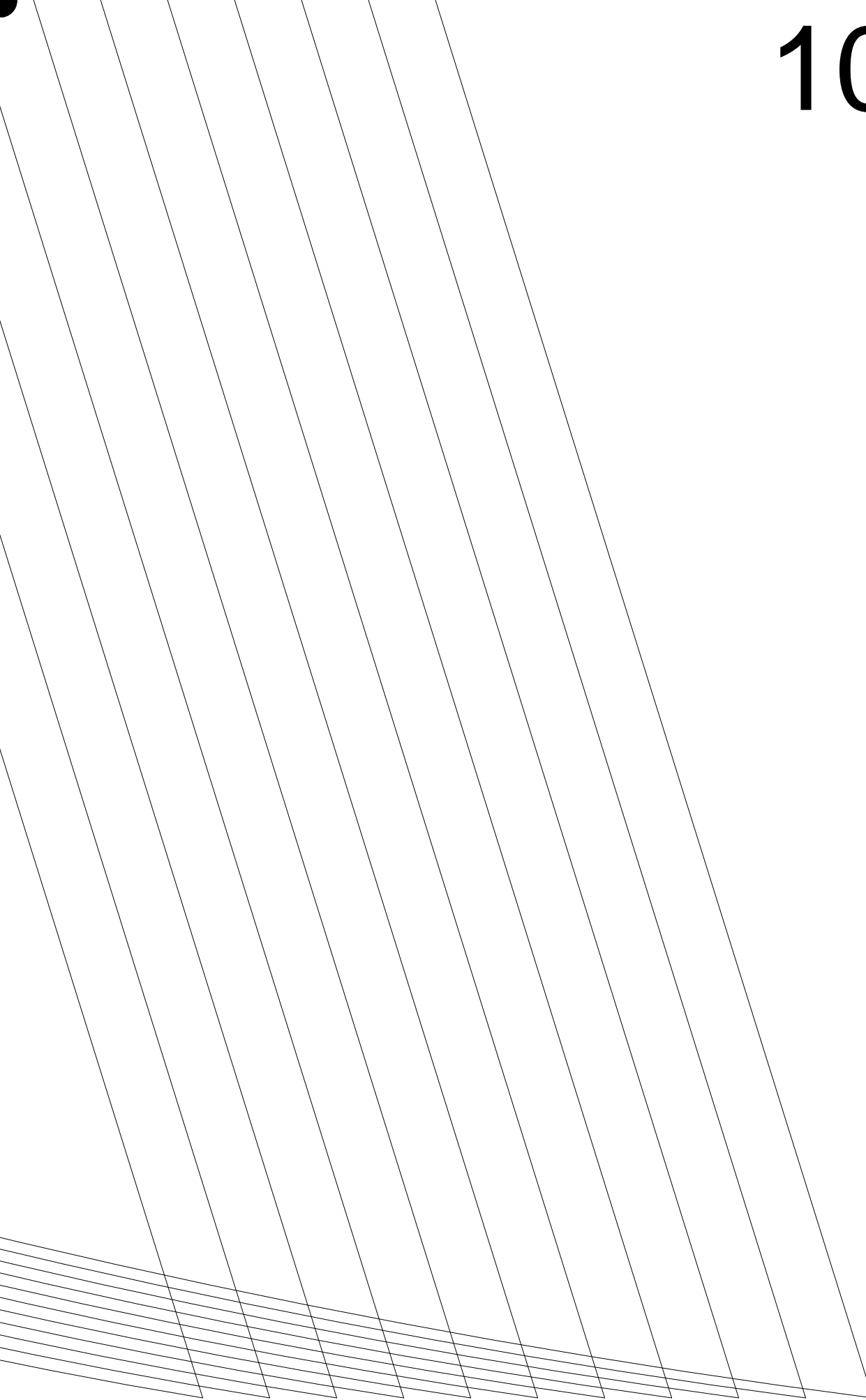

13

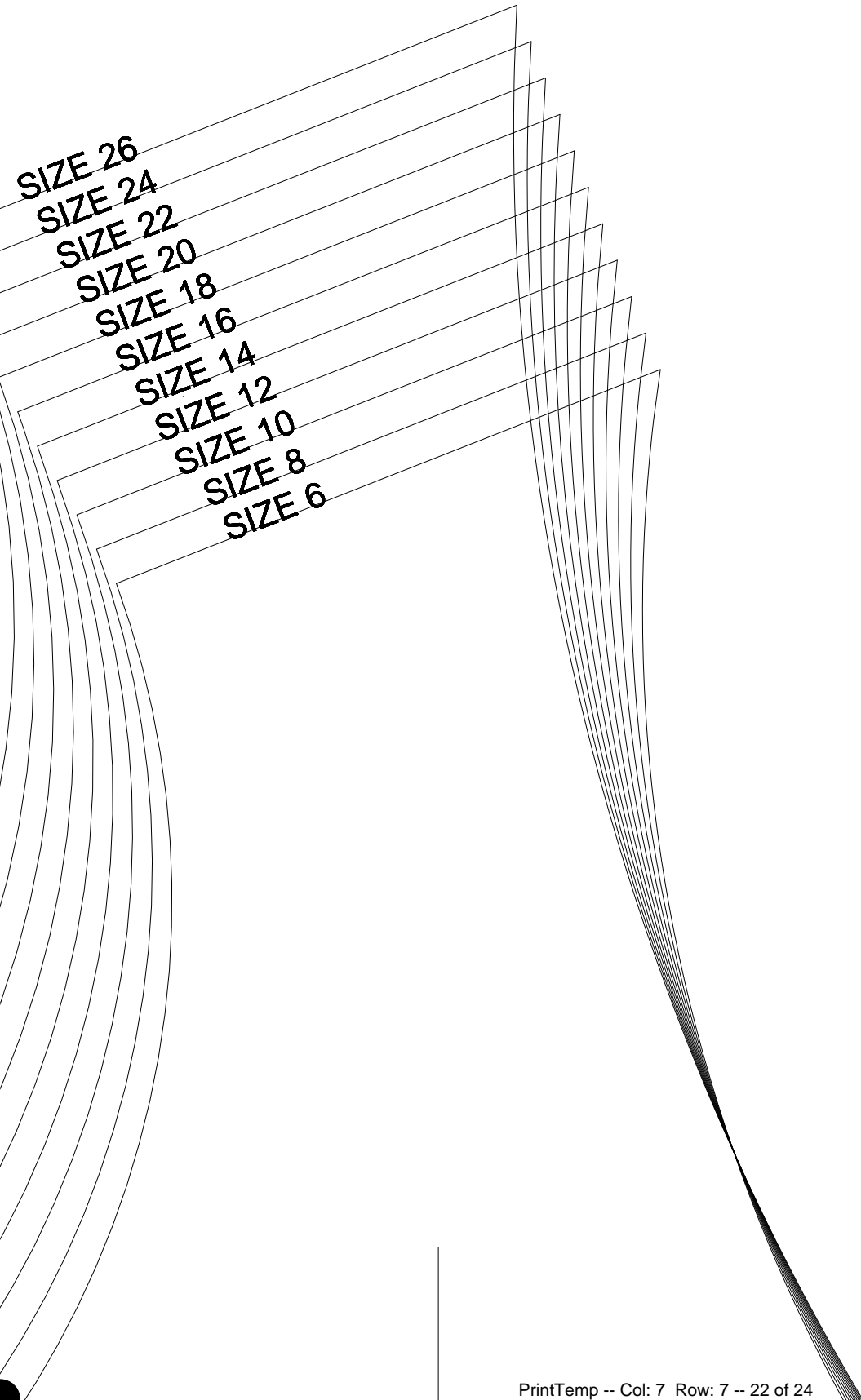

19

ms & fabric.com

free download
reezy knit vest
front
pair in fabric

SECTION _____

